

00054830
(DIR3120)

hama®

THE SMART SOLUTION

Digital Radio

Digitalradio

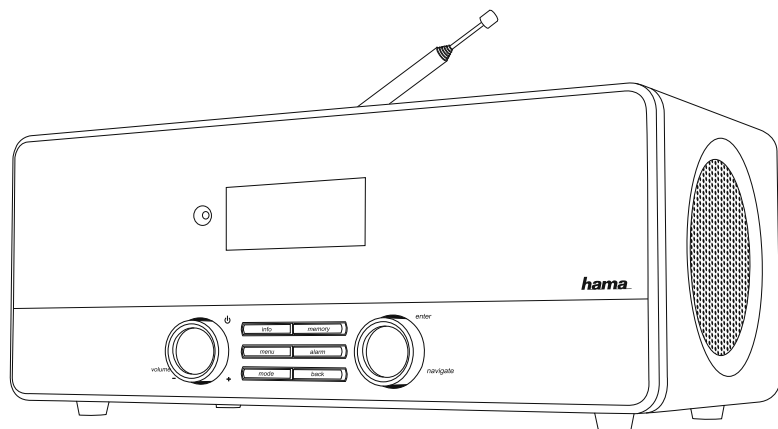

Operating Instructions / Bedienungsanleitung / Mode d'emploi / Instrucciones de uso /
Руководство по эксплуатации / Istruzioni per l'uso / Gebruiksaanwijzing / Οδηγίες χρήσης / Instrukcja obsługi /
Használati útmutató / Návod k použití / Návod na použitie / Manual de instruções / Kullanma kılavuzu /
Manual de utilizare / Bruksanvisning / Käyttöohje / Работна инструкция / Betjeningsvejledning / Manuelt stasjonssøk

Technical Data / Technische Daten

Radio Receiver/ Radio Empfänger	DAB +	DAB+ +	FM +	Internet +	Spotify +
Connectivity/ Verbindungsfähigkeit	LAN (10/100), WIFI(b/g/n), USB (Play/Charge 5V $\overline{=}$ 1A)				
Display/ Bildschirm	2.4" oLED-Display				
Encryption/ Verschlüsselung	WEP, WPA, WPA2, WPS				
Speaker/ Lautsprecher	20 W RMS (2x 10 W)				
Impedance/ Impedanz	6 Ohm Speaker		75 Ohm Antenna		
Power input/ Stromeingang	110-240 V ~ 50-60Hz				
Frequency range/ Frequenzbereich	DAB/DAB+: 174-240 MHz		FM: 87.5-108 MHz		
Sensitivity/ Empfindlichkeit	DAB/DAB+: -97 ~ 99 dBm		FM: -105 ~ 109 dBm		
Power Consumption/ Stromaufnahme	Operation/ Betrieb	24 W	Standby/ Bereitschaft	~ 1 W	
Input & Output/ Anschlüsse	Line Out, Aux in, 3.5 mm Earphone Jack, RJ45				
Presets/ Favoriten	DAB/DAB+: 30	FM: 30	Internet: 30		
Codec/ Formate	IR: MP3, WMA, ADTS	UPNP: MP3, WMA v9/ASF, M4A, ADTS, WAV, LPCM, FLAC, ALAC		DAB: MP2, AAC	USB Stick: MP3, WMA
UI Languages/ UI Sprachen	English, Danish, Dutch, Finnish, French, German, Italian, Norwegian, Polish, Portuguese, Spanish, Swedish, Turkish				
Package Content/ Verpackungsinhalt	Manual, Spotify sheet, remote control, AAA batteries, EU Power Cord, UK Power Cord/ Bedienungsanleitung, Spotify flyer, Fernbedienung, AAA Batterien, Anschlusskabel für Euro-Steckdosen, Anschlusskabel für UK-Steckdosen, Antennenschlüssel				
Dimension (WxD)/ Größe (BxHxT)	293 x 122 x 160 mm				
Weight/ Gewicht	2200 g				

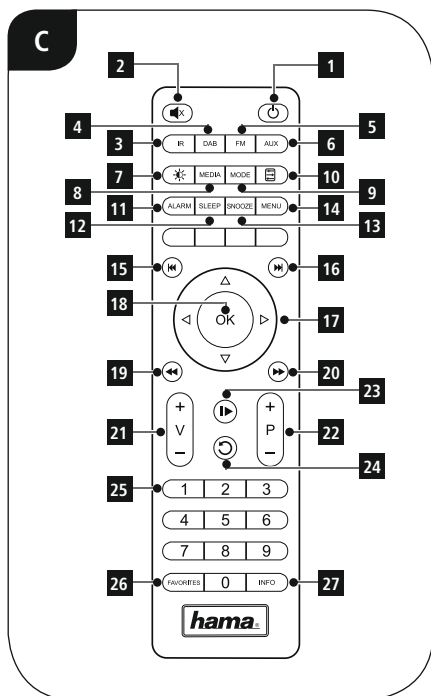
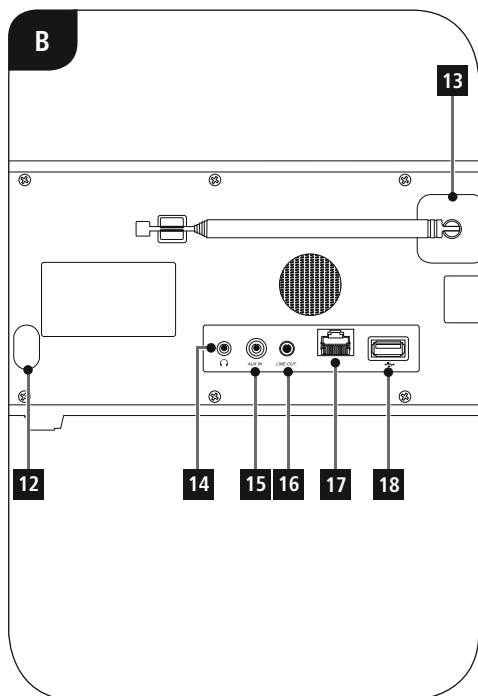
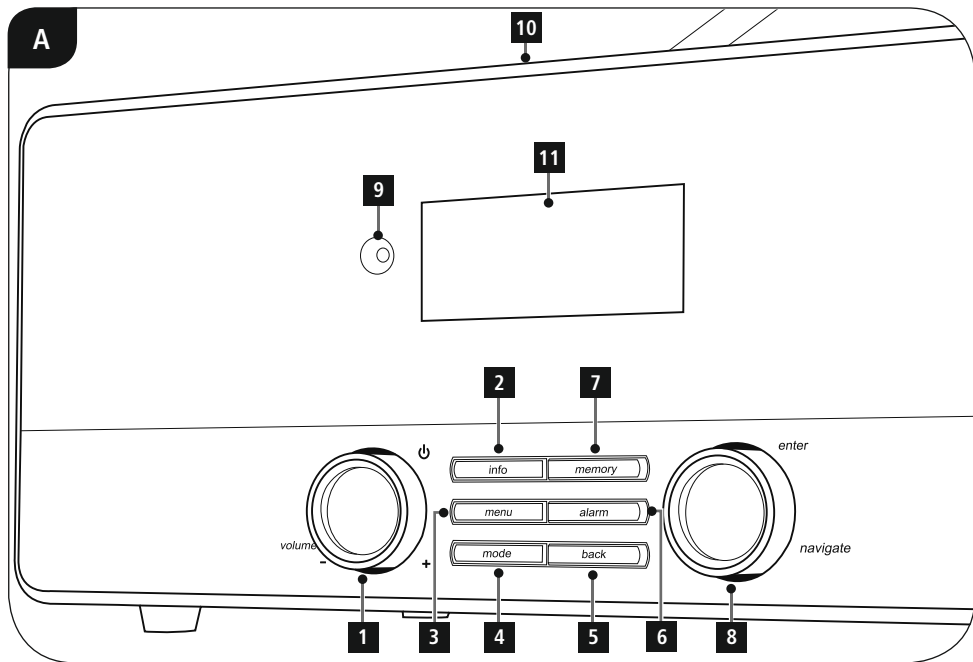

Controls and Displays

A: Front		
1	[volume +/-] / [⏻]	Rotate: Volume control Press: On/off switch
2	[info]	Display additional information
3	[menu]	Direct access to the menu
4	[mode]	Changing operating mode (Internet radio, Spotify Connect, Music player, DAB, FM, Aux in)
5	[back]	Back one menu level
6	[alarm]	Direct access to alarm clock settings
7	[memory]	List/save favourites
8	[enter/ navigate]	Rotate: Select Press: Confirm
9		Infrared receiver
10	[🔔 Zzz]	Snooze settings/ Activating Snooze
11		2.4" oLED-Display

B: Rear		
12		Mains power supply
13		Antenna*
14		Headphone socket
15		AUX IN socket
16		LINE OUT socket
17		LAN connection
18		USB connection

Note

* This radio has a changeable antenna. You can use an active or passive antenna equipped with a coaxial connection.

C: Remote Control		
1	[⏻]	On/off switch △ Press [volume +/-]/ [⏻]
2	[🔊 X]	Mute
3	[IR]	Direct access to operating mode Internet radio △ [mode]
4	[DAB]	Direct access to operating mode DAB △ [mode]
5	[FM]	Direct access to operating mode FM △ [mode]
6	[AUX]	Direct access to operating mode Aux in △ [mode]
7	[☀️]	Backlight settings
8	[MEDIA]	Direct access to operating mode Music player △ [mode]
9	[MODE]	Changing operating mode (Internet radio, Spotify Connect, Music player, DAB, FM, Aux in) △ [mode]
10	[📊]	Equaliser settings
11	[ALARM]	Direct access to alarm clock settings △ [alarm]
12	[SLEEP]	Snooze settings △ [🕒 Z²z²]
13	[SNOOZE]	Activating Snooze △ [🕒 Z²z²]
14	[MENU]	Direct access to the menu △ [menu]
15	[⏮]	previous track (operating mode: Spotify Connect, Music player)
16	[⏭]	next track (operating mode: Spotify Connect, Music player)
17	Navigationstasten	▲ Up / ▼ Down / ◀ Back one menu level △ [back] / ▶ Forward/ Confirm △ Press [enter/navigate]/[OK]

18	[OK]	Confirm △ Press [enter/navigate]
19	[⏮]	Rewind (operating mode: Spotify Connect, Music player)
20	[⏭]	Fast forward (operating mode: Spotify Connect, Music player)
21	Lautstärketasten [+]/[-]	Volume control △ Rotate [volume +/-]/ [⏻]
22	Favoriten-tasten [+]/[-]	Selection from favourites list
23	[⏪]	Start/ Stop playback (operating mode: Spotify Connect, Music player, Aux in)
24	[↶]	Back one menu level △ [back]
25	Nummern-tasten	Direct access to favourites/ Save favourites
26	[FAVORITES]	List/save favourites
27	[INFO]	Display additional information △ [info]

Content

1. Explanation of Warning Symbols and Notes	7
2. Package Contents	7
3. Safety Notes	7
4. Informations and notes before getting started	8
4.1 LAN connection (wired network)	8
4.2 WLAN connection (wireless network)	8
5. Getting started	8
5.1 Remote control	8
5.2 Radio – Connecting and starting up	9
5.3. General notes on use	9
5.4 Initial setup	11
6. Main menu / modes	12
7. Internet radio	12
7.1 Station search	13
7.1.1 Search by country or region	13
7.1.2 Search by genre	13
7.1.3 Search by name.	13
7.1.4 Popular stations	13
7.1.5 New stations	14
7.1.6 Local stations	14
7.2 Podcasts	14
7.2.1 Search by country or region	14
7.2.2 Search by format (subjects or categories)	14
7.2.3 Search by name.	15
7.3 Last listened	15
7.4 Favourites (local)	15
7.4.1 Save favourites	15
7.4.2 Access favourites.	15
7.4.3 Management of favourites with the remote control	16
7.5 Favourites (vTuner - http://www.wifiradio-frontier.com)	16
7.5.1 First use – Registering your radio.	16
7.5.2 Managing favourites online (vTuner - http://www.wifiradio-frontier.com)	17
7.5.3 Opening the favourites list.	17
7.5.4 My Added Stations	17
8. Spotify	17
9. Music player (UPNP, USB)	19
9.1 Playback from external storage media (USB).	19
9.2 Playback from a computer (streaming)	19
9.3 Playback from the network – Accessing files using the radio	20
9.4 Playback of playlist	20
9.5 General playback options	21
10. DAB	21
10.1 Search/ Automatic search.	21
10.2 Manual station search	22
10.3 Station list.	22
10.4 Sort station list	22
10.5 Edit station list.	23
10.6 Favourites	23
10.6.1 Save favourites.	23
10.6.2 Access favourites.	23
10.6.3 Management of favourites with the remote control	23
10.7 DRC (Dynamic Range Control)	24
11. FM	24
11.1 Scan setting	24
11.2 Automatic station search	25
11.3 Manual station search	25
11.4 Favourites	25
11.4.1 Save favourites	25
11.4.2 Access favourites.	25
11.4.3 Management of favourites with the remote control	25
11.5 Audio setting	26
12. Auxiliary Input.	26
13. Sleep	26
14. Alarms	27
14.1 Alarm settings	27
14.2 Activating/ deactivating the alarm	27
14.3 Stopping the alarm/ Snooze function	28
15. System settings	28
15.1 Equaliser	28
15.2 Network	29
15.2.1 Network wizard – Configuration of internet connection / Automatic search	29
15.2.2 Wireless network connection (WLAN)	29
15.2.3 Wired network connection (LAN)	30
15.2.4 Manual configuration of network connection – wireless (WLAN) and wired (LAN)	30
15.2.5 View settings.	31
15.2.6 NetRemote PIN Setup / Smart Radio-App	31
15.2.7 Network profile.	32
15.2.8 Keep network connected.	32
15.3 Time/ Date	32
15.4 Language	33
15.5 Factory Reset	33
15.6 Software update	33
15.7 Setup wizard	34
15.8 Info	34
15.9 Backlight	34
15.10 AUX: Auto-Standby	35



16. Hama Smart Radio (Android / iOS)	35
16.1 Preparation	35
16.2 First startup	35
16.4 Source selection	36
16.5 Station search and favourites	37
16.5.1 Managing favourites	37
16.5.2 Searching for stations / station lists	37
16.6 Settings and standby	38
16.7 Additional functions (music player / Spotify)	38
17. Care and Maintenance	38
18. Warranty Disclaimer	38
19. Service and Support	39
20. Recycling Information	
Note on environmental protection:	39
21. Declaration of Conformity	39



Menu structure

MAIN MENU

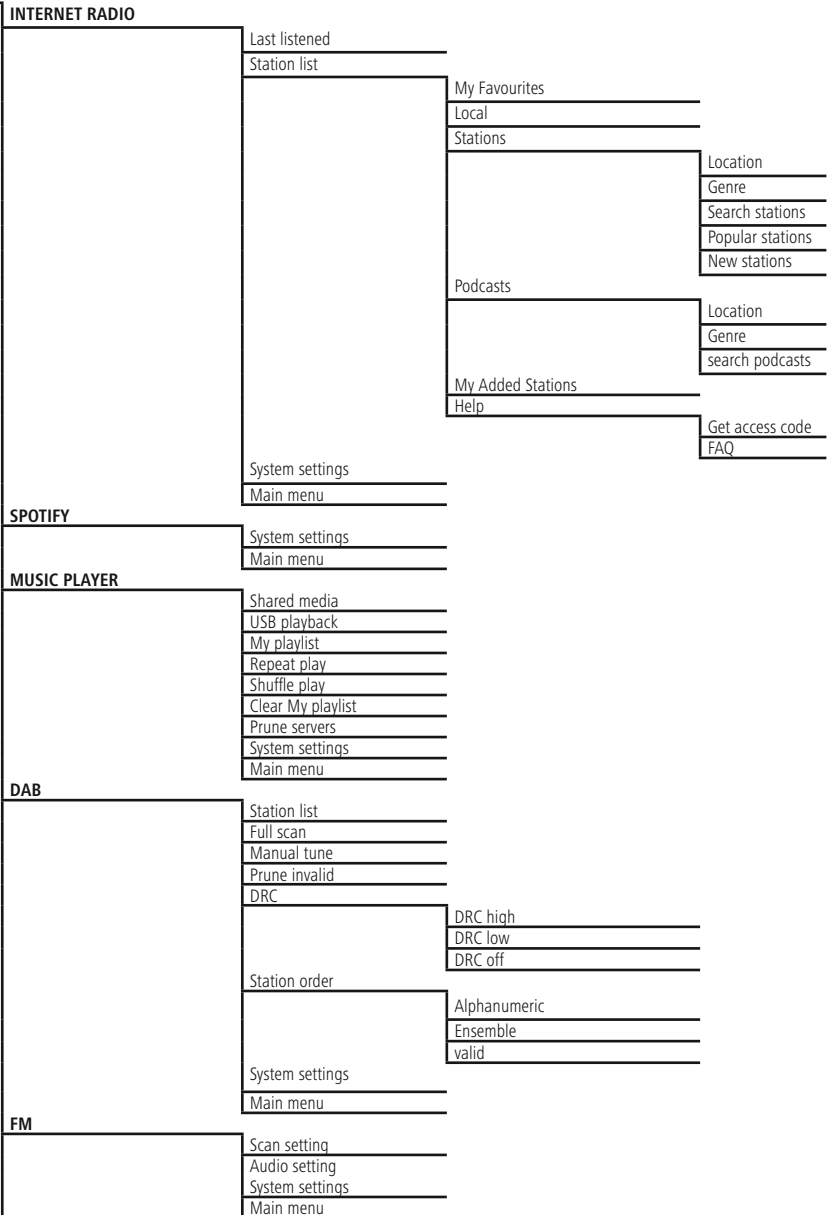

AUXILIARY INPUT			
	System settings		
	Main menu		
SLEEP			
ALARMS			
SYSTEM SETTINGS			
	Equaliser		
		Normal	
		Flat	
		Jazz	
		Rock	
		Movie	
		Classic	
		Pop	
		News	
		My EQ	
		My EQ profile setup	
			Bass
			Treble
			Loudness
	Network		
		Network wizard	
		PBC Wlan setup	
		View settings	
		Manual settings	
		NetRemote PIN Setup	
		Network profile	
		Keep network connection	
	Time/Date		
		Set Time/Date	
		Auto update	
			Update from Network
			No update
		Set format	
		Set timezone	
		Daylight savings	
	Language		
	Factory Reset		
	Software update		
		Auto-check setting	
		Check now	
	Setup wizard		
	Info		
	Backlight		
		Slumber Mode	
		Operation Mode	
		Standby Mode	
			Timeout
			Standby Level
	AUX: Auto-Standby		



Thank you for choosing a Hama product.

Take your time and read the following instructions and information completely. Please keep these instructions in a safe place for future reference. If you sell the device, please pass these operating instructions on to the new owner.

1. Explanation of Warning Symbols and Notes



Risk of electric shock

This symbol indicates product parts energized with a dangerous voltage of sufficient magnitude to constitute a risk of electric shock.



Warning

This symbol is used to indicate safety instructions or to draw your attention to specific hazards and risks.



Note

This symbol is used to indicate additional information or important notes.

2. Package Contents

- Digital radio DIR3120
- Telescopic antenna with coaxial connection
- Remote Control
- 2x AAA batteries
- Quick guide
- Spotify Connect brochure
- EU Power Cord
- UK Power Cord
- Antenna key

3. Safety Notes

- The product is intended for private, non-commercial use only.
- Protect the product from dirt, moisture and overheating and use it in dry rooms only.
- As with all electrical devices, this device should be kept out of the reach of children.
- Do not drop the product and do not expose it to any major shocks.
- Do not operate the product outside the power limits given in the specifications.
- Keep the packaging material out of the reach of children due to the risk of suffocation.
- Dispose of packaging material immediately according to locally applicable regulations.
- Do not modify the device in any way. Doing so voids the warranty.



Risk of electric shock

- Do not open the device or continue to operate it if it becomes damaged.
- Do not use the product if the AC adapter, adapter cable or power cable is damaged.
- Do not attempt to service or repair the product yourself. Leave any and all service work to qualified experts.



Warning Batteries

- When inserting batteries, note the correct polarity (+ and - markings) and insert the batteries accordingly. Failure to do so could result in the batteries leaking or exploding.
- Do not allow children to change batteries without supervision.
- Remove the batteries from products that are not being used for an extended period.
- Do not short-circuit batteries.
- Do not charge batteries.
- Do not throw batteries in a fire.
- Keep batteries out of the reach of children.
- Do not mix old and new batteries or batteries of a different type or make.



4. Informations and notes before getting started

Note – Optimal reception

- This product is equipped with an antenna connection which allows the use of an active or passive antenna. The antenna is connected with a coaxial F-connector.
- A telescopic antenna that enables DAB, DAB+ and FM reception is included in the delivery.
- For best reception, ensure that the antenna is fully extended and vertical.
- Try various different positions if necessary to get the best reception.

Network connection/

Preparing the internet connection

You can integrate this radio into a local network and even access home servers or other authorised resources. To receive internet radio or access non-local media (streaming, such as Spotify Connect), the network must be connected to the internet.

Note

The LAN connection is less susceptible to faults than a WLAN connection. That's why it's recommended to use a wired connection between access point (AP) and radio to ensure an undisturbed reception.

4.1 LAN connection (wired network)

- Connect a LAN cable of type RJ45 to a free socket on your router, switch or access point.
- Connect the other end of the LAN cable to the RJ45 LAN socket on the radio.
- Make sure that the router is on and that you have an Internet or network connection.
- If you have questions about router configuration, please consult the operating manual of the router for troubleshooting.
- A detailed description of how to configure the LAN connection is given in the **Wired network connection (LAN)** section.

4.2 WLAN connection (wireless network)

- Ensure that the router is switched on, is functioning correctly and that there is a connection to the internet.
- Activate the WLAN function of your router.
- Follow your router's operating instructions as regards the correct functioning of the WLAN connection.
- A detailed description of how to configure the LAN connection is given in the **Wireless network connection (LAN)** section.

5. Getting started

5.1 Remote control

- Open the battery compartment cover. It is located on the rear of the remote control.
- Pull the closing tab back (if present) and lift the cover. With other models of remote control, it suffices to simply push the casing in the direction indicated.

A: Closing tab



B: Sliding cover

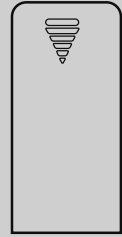

Insert the batteries provided, paying attention to match the polarities correctly. The correct polarity is indicated by the plus and minus symbols in the battery compartment.

5.2 Radio – Connecting and starting up

Connect the network cable to a properly installed and easily accessible network socket.

The power supply unit is suitable for mains voltages between 100 and 240 V, and is thus operable on almost any AC power grid. Please note that a country-specific adapter may be necessary.

You can find an appropriate selection of Hama products at www.hama.com.

Note

- Only connect the product to a socket that has been approved for the device. The electrical socket must always be easily accessible.
- When using a multi-socket power strip, make sure that the sum power draw of all the connected devices does not exceed its maximum throughput rating.
- If you will not be using the product for a long period of time, disconnect it from mains power.





Once the product has been connected to mains power, initialisation takes place.

The radio starts up, and a list of available languages for the menu is displayed.

To assist you in first-time setup of the radio, a **Setup Wizard** is provided.

5.3. General notes on use

Notes on use

- In the following operating instructions, we will focus on operating the device via the front panel. We will deal with functions separately that are only available on the app or the remote control.
- The buttons on the remote control – corresponding to the control buttons on the device () - you will find under Controls and Displays.
- **[OK]** and the navigation button  on the remote control correspond to pressing **[enter/navigate]**.
- The navigation key  on the remote control has the same function as **[back]** on the front of the radio.
- The navigation keys  /  on the remote control have the same function as turning **[enter/navigate]** on the front of the radio to the left and right.
- When a selection among menu items is to be made (such as **YES** or **NO**), the one currently selected has a light-coloured background fill.
- In menus offering a variety of different options (such as Equalizer, Update, and so on), the currently selected option is marked with **#**.



Navigation and controls

- Select among menu items by turning **[enter/navigate]**.
- Confirm the selection by pressing **[enter/navigate]**.

This procedure is indicated in these operating instructions by the following symbols:

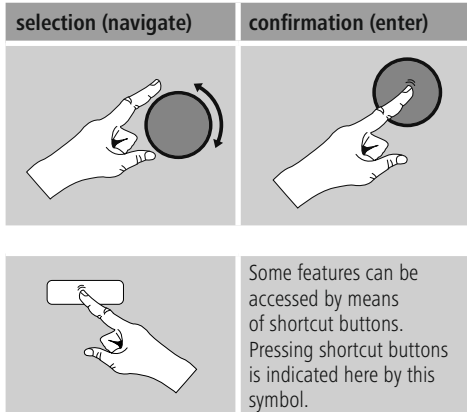

After pressing a shortcut button, navigate amongst the menu items using **[enter/navigate]**.

Volume adjustment / mute

- You can turn the volume up (right) or down (left) by turning **[volume -/+]** / **[⏻]** accordingly.
- Press **[⏻]** on the remote control to mute the radio.
- Press **[⏻]**, on the remote control again to reset the volume at the level you set before mute the radio.

Entering passwords, search terms, and so on

- Select each successive letter and digit by turning **[enter/navigate]** and confirm each selection by pressing **[enter/navigate]**.
- To make corrections, select **BKSP** and confirm. The last input made is deleted.
- To cancel input, select **CANCEL** and confirm.
- Once your input is complete, select **OK** and confirm to finish.
- Press **[info]** to jump directly to the **BKSP/ OK/ CANCEL** fields.

Additional information

Press **[info]** to display context-dependent additional information. The information shown depends on the operating mode as well as the current selection of radio station, music file, etc.

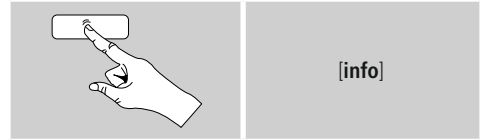

• Description

Indicates the radio station, the current program, contents, subjects, etc.

• Program genre/country

Indicates the genre (music style) and the country or region of the station.

• Reliability

• Bit-Rate

The currently received digital bit rate of the received station is displayed.

• Codec

Specifies the encoding scheme used to digitise the data or signal (such as MP3 or WMA).

• Sampling rate

Specifies the sampling rate, or the frequency with which the audio signal is polled (Sampling-/ Samplerate), in a certain period of time.

• Signal strength

The signal strength of the received station is displayed via a bar and its length.

• Today's date

• Artist

• Album

• Folder

• Path

Specifies the directory path at which the file currently being played back is saved.

Switching on/off / Standby

- Press **[volume -/+]** / **[⏻]**, to switch the radio on or off (Standby).
- To completely switch off the device, disconnect it from the power supply.



5.4 Initial setup

When it is first connected to the power supply, a list of available languages for the menu is displayed. Proceed as follows to set your preferred language.

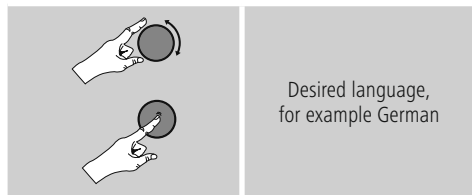

Setup wizard

Once a language has been set, the setup wizard offers to assist you with first-time setup. Choose **YES** to start it or **NO** to skip.

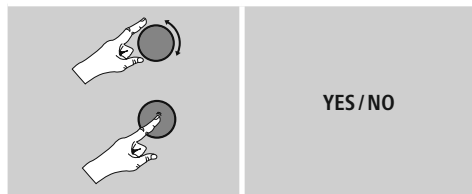

i Note – Starting up with or without the setup wizard?

- We recommend using the setup wizard (**YES**) to quickly and easily configure the time, date, internet connection, etc.
- If you wish to skip setup with the setup wizard anyway, choose **NO**. All of the settings configured by the setup wizard can be configured or changed individually in the System settings menu. Alternatively, you may restart the setup wizard at any time.
- Next, choose **YES** or **NO** to define whether the setup wizard should start automatically next time the radio is started up. You are in the main menu.

Date/ Time

• 12/24 hours format

• Auto update

• Update from DAB/ FM

If automatic time and date adjustment is activated, the device receives time and date information from the station over the FM/DAB/ DAB+ radio network. This is the best way to ensure that the clock will run accurately and the alarm will trigger at the correct time, even after power outages.

• Update from Network

Choose this option to set the time and date automatically from the internet. Set the timezone of your current location and, if desired, turn (**ON**) automatic adjustment between summer time and winter time.

• No update

The time and date (**DD-MM-YYYY**) must be set manually; no automatic calibration takes place.

Keep network connected

This setting is a radio energy-saving function. If this feature is disabled (**NO #**), the network module will be switched off whenever the radio is not actively using the network connection (such as in standby mode). This means the radio will not be accessible via the network from your PC, smartphone or tablet.

You should enable (**YES #**) this menu item if you want to use streaming or control functions via the app. This function is disabled by default.

Network wizard – Configuration of network connection

i Note – Reference to a different part of these operating instructions.

- Because this chapter is extensive, please follow the directions in section 15.2.1. Network wizard – Configuration of internet connection



Once the network wizard has finished, the setup wizard is finished as well. The display shows a message to this effect. Press **[enter/navigate]** to enter the main menu.

6. Main menu / modes

Access the main menu as follows:

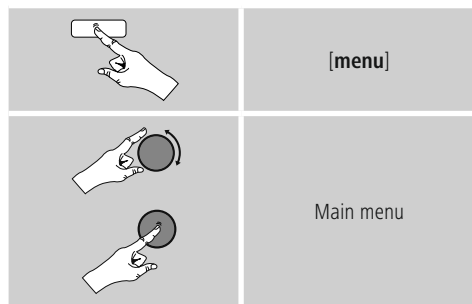

The main menu contains the various operating modes as well as other options that are explained separately in the following chapters.

7. **Internet radio**
8. **Spotify**
9. **Music player**
10. **DAB**
11. **FM**
12. **Auxiliary Input**
13. **Sleep**
14. **Alarms**
15. **System settings**

Select amongst the available operating modes by repeatedly pressing **[mode]**.



7. Internet radio

The radio uses the station list on the vTuner* portal. You can use stations without direct registration on the following portal: <http://www.wifiradio-fronter.com>. You will find detailed operating instructions under Section

7.5 Favourites

Note

* If necessary, it is possible to switch providers in order to make all features and functions of the product available.

From the main menu or after pressing **[mode]** repeatedly, activate **Internet radio** mode.

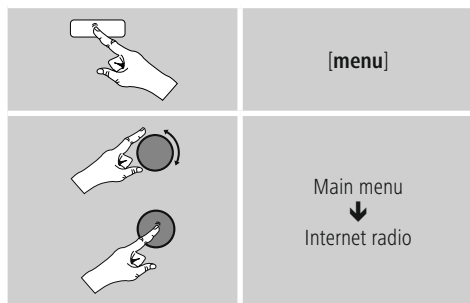

Alternatively, press **[IR]** on the remote control to switch directly to this operating mode.

7.1 Station search

This radio offers various ways to search for stations.

- Use **[enter/navigate]** to navigate through each search function and its options.
- Once you have found a station you like, confirm by pressing **[enter/navigate]**. The radio starts playing the selected station.

7.1.1 Search by country or region

To search for a station by continent, country and region, proceed as follows:

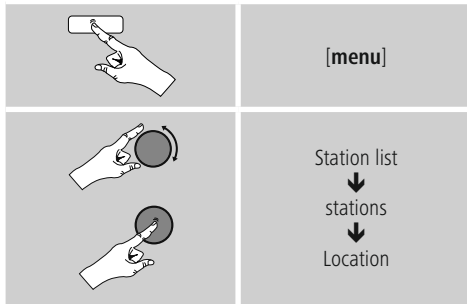

Once you have restricted the results to a certain country or region, select a station from the complete list or from a list sorted by genre.

7.1.2 Search by genre

To search for a station of a certain genre or subject focus, proceed as follows:

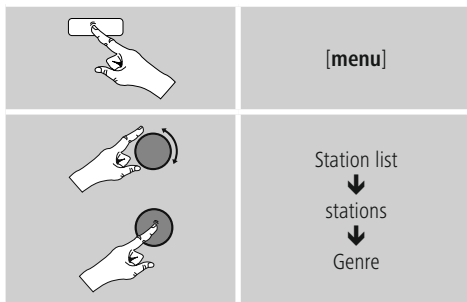

Once you have restricted the results to a certain genre, select a station from a list of all stations available, or from a pre-selected list, or from a list sorted by country.

7.1.3 Search by name

If you know the name of the desired station, you can search for it directly.

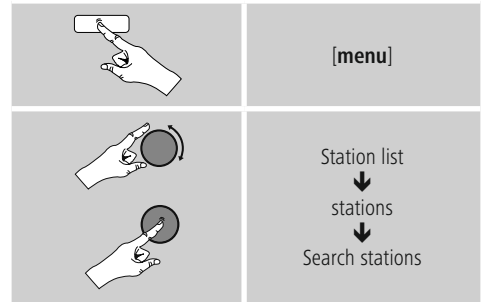

Enter the complete name, or a part thereof, in the input screen and select **OK** to start the search. You receive a list of all available stations whose names contain the search key.

7.1.4 Popular stations

You can find a selection of the most popular stations as follows:

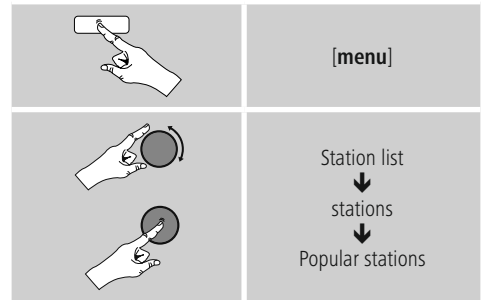

7.1.5 New stations

Stations that have recently been added to the database can be found as follows:

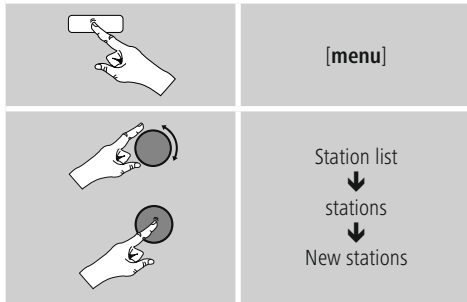

7.1.6 Local stations

To search for stations from your own country (the country in which the radio is currently located), proceed as follows:

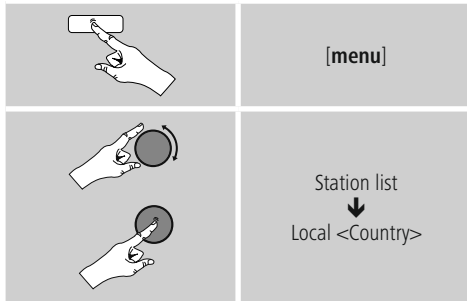

Note

Replace the <Country> placeholder with the country you are currently located in.

You can filter this local list by genre, or select a station from the complete list, or select from a pre-selected list.

7.2 Podcasts

Podcasts are programs on various topics and include, for example, talk shows, news and much more. Podcasts can be downloaded from the Internet. There are normally approximately 10,000 programs available. Similarly to radio stations, the radio makes it possible to filter a large number of Podcasts, or to search the entire database for a matching result.

7.2.1 Search by country or region

To search for a podcast by continent, country and region, proceed as follows:

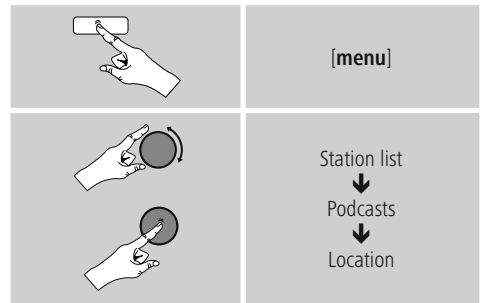

Once you have restricted the results to a certain country or region, select a station from the complete list or from a list sorted by genre.

7.2.2 Search by format (subjects or categories)

To search for a podcast by continent, country and region, proceed as follows:

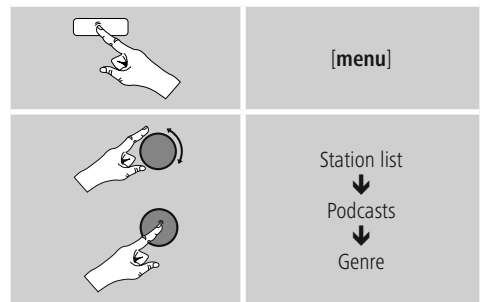

7.2.3 Search by name

If you know the name of the desired Podcasts, you can search for it directly.

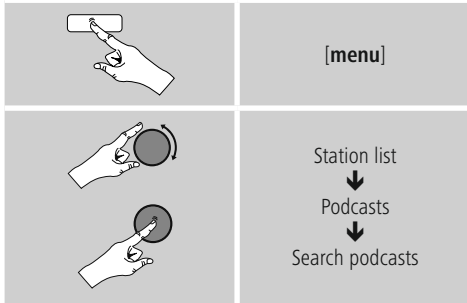

Enter the complete name, or a part thereof, in the input screen and select **OK** to start the search. You receive a list of all available Podcasts whose names contain the search key.

7.3 Last listened

The radio saves the last stations and podcasts listened to in their own list. To access the list, proceed as follows:

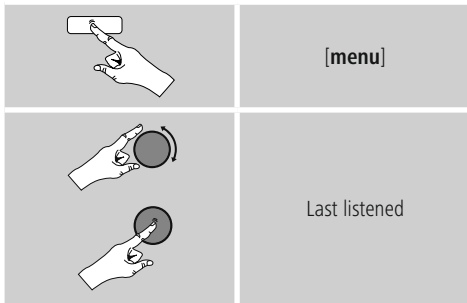

7.4 Favourites (local)

You can save up to 30 of your favourite stations for quick and direct access.

7.4.1 Save favourites

- Set the station that you would like to save as a favourite station preset.
- If the station is received, press and hold **[memory]** on front of the radio.



An overview window with the station presets should open after approx. 2 seconds.

- You can switch between the station presets (1 to 30) by turning **[enter/navigate]**.
- Press **[enter/navigate]** to save the station on the desired station preset.

7.4.2 Access favourites

Press **[memory]** to open the overview window with the list of saved stations.



Use **[enter/navigate]** to select one of your favourites.

Note

Favourites cannot be deleted.

If all 30 station memory slots are filled and you wish to save a new station, choose one of the occupied slots. The station in this slot will be overwritten with the new station.



7.4.3 Management of favourites with the remote control

Favourites 1-10

The remote control enclosed has number keys 1-0 (0 \triangleq 10). A favourite can be assigned to each of these number key.

- To save a favourite, press and hold the corresponding number key on the remote control (approx. 3 seconds).
- The radio confirms that the favourite has been saved by displaying **Preset stored**.
- To call up a favourite, briefly press the corresponding number key on the remote control.

Favourites 1-30 (alternative to number keys)

- Press and hold **[FAVORITES]** approx. 3 seconds to save a station on one of the 1-30 favourite station presets. An overview window with the station presets should open after approx. 2 seconds.
- You can switch between the station presets (1 to 30) by pressing the favourite keys **[+]/[-]** (by turning **[enter/navigate]**).
- Press **[OK]** (**[enter/navigate]**) to save the station on the desired station preset.
- To call up a favourite, briefly press **[FAVORITES]**, select the desired station preset by pressing the favourite keys **[+]/[-]** (by turning **[enter/navigate]**) and confirm the selection by pressing **[OK]** (**[enter/navigate]**).

7.5 Favourites (vTuner - <http://www.wifiradio-frontier.com>)

In addition to the local station memory slots, you can create additional lists of favourites using the vTuner database.

Lists of favourites created using the vTuner database can be synchronised across multiple radios.

7.5.1 First use – Registering your radio

In order to be able to use this function you have to register at **www.wifiradio-frontier.com**. You need a valid email address and an access code which will be generated by your radio.

Note

- No personal information is collected during the registration process.
- Registering does not cost you anything extra. The offer is completely free.
- Following registration you can choose from around 20,000 radio stations and 10,000 podcasts.

Get access code:

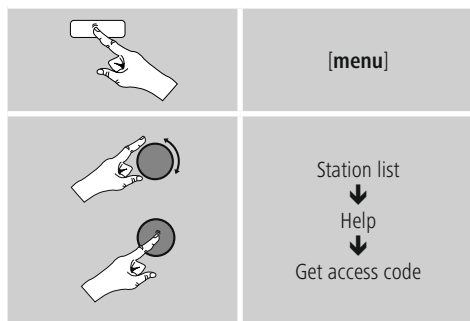

Note

Please note that each access code can only be used once. Please contact customer service if you should experience problems while registering the radio.

- During registration, the radio's ID is associated with your e-mail address and saved in the web interface.
- If multiple radios are registered to you and you wish to delete one of those registrations or just compare them, you can find the radio's ID as follows.

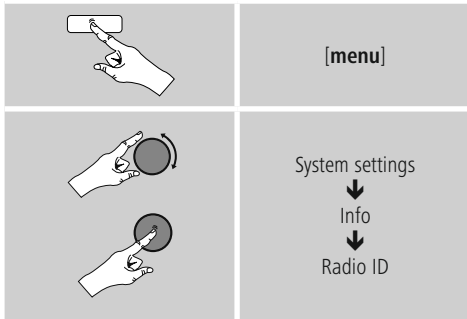

7.5.2 Managing favourites online (vTuner - <http://www.wifiradio-frontier.com>)

After registering on the portal, you can search through the station archive using various filters, try out stations, and create your own favourites list from the stations listed there. The favourites list is then synchronised with your radio in a matter of seconds.

7.5.3 Opening the favourites list

To open the favourites list you created on the portal using the radio, proceed as follows:



7.5.4 My Added Stations

If a station you desire is not yet available, you can add it manually to the portal, or suggest a station be added to the database (Recommend station).

- You need the web address of the stream, which can often be found on the station's website.
- You can access the added radio stations as follows:

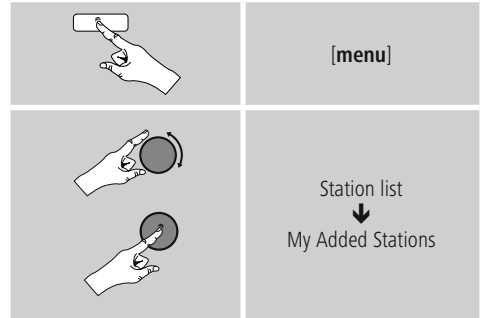

The database is constantly expanded and maintained. Nevertheless, we hope you'll understand that sometimes there can be delays in integrating new stations and some stations are even rejected.

8. Spotify

Spotify Connect gives you access to millions of songs. You can listen to them on your radio, on the go using your smartphone, or at your PC.

Requirements:

- You must have the Spotify app installed on your Android or iOS device.
- It can be downloaded from the Play Store or the Apple App Store. Once the app is installed, start it and log into your account (or, if you do not have an account, register a new one).
- You will require a Spotify Premium account (see www.spotify.de for more information).
- The radio must be on the same network as the Android or iOS device with the Spotify app installed.



Use:

- In the Spotify app, start playback of a playlist or title as usual.
- The usual playback information is displayed, such as the album cover, title, etc.
- At the bottom edge of the screen, the Spotify Connect logo  is shown next to **Available devices**.

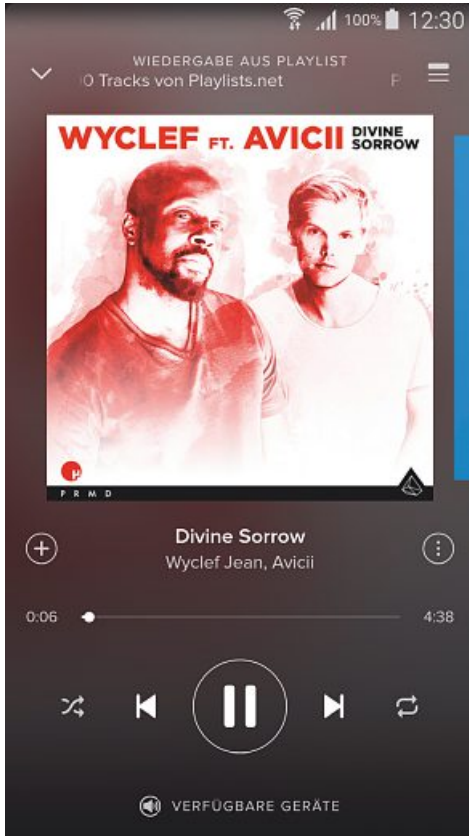

Playback display

- Choose  **Available devices** to access an overview of all devices available on the network.
- Select the radio. The audio is now played back on the radio.

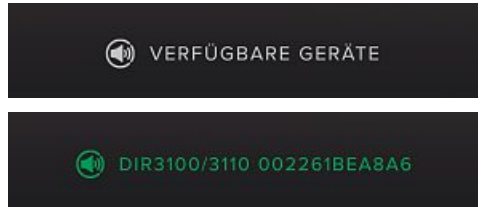

Once the connection has been established, the Spotify Connect logo  and the device designation are displayed in green.

After successful initial connection:

From the main menu or after pressing **[mode]** repeatedly, activate **Spotify (Spotify Connect)** mode.

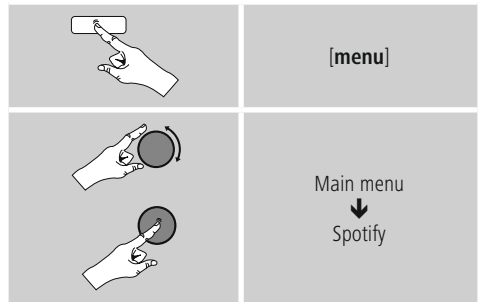

- Press **[enter/navigate]** (or ) on the remote control to begin playback.
- Alternatively, you can control the radio (skip to a different title, adjust the volume, etc.) using the remote control, the Smart Radio app, or the Spotify app.



9. Music player (UPNP, USB)

This operating mode enables the playback of MP3, WMA or FIAC files that are saved on a PC, data storage medium or the local network.

From the main menu or after pressing **[mode]** repeatedly, activate **Music player** mode.

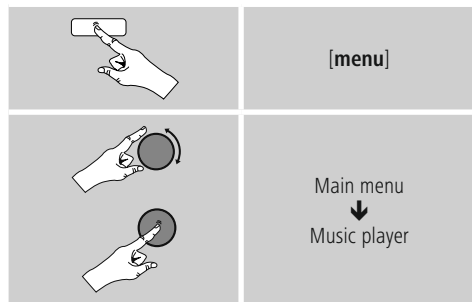

Alternatively, press **[MEDIA]** on the remote control to switch directly to this operating mode.

9.1 Playback from external storage media (USB)

- Insert a storage device (such as a USB stick) into the USB port of the radio.
- The storage medium should be formatted as a FAT16 or FAT32 volume.
- The radio recognises the storage medium automatically.
- When the radio asks whether to open the connected storage device, confirm by selecting **YES**.
- The files and folders saved on the storage medium are displayed. Use **[enter/navigate]** to choose the desired file and begin playback

Alternatively, if the storage medium is already connected, choose the desired file for playback as follows:

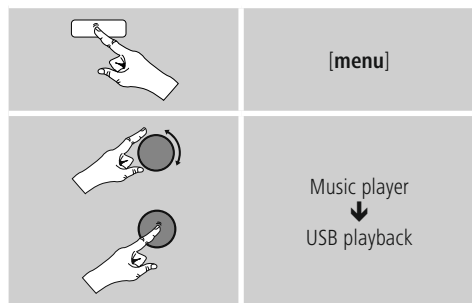

9.2 Playback from a computer (streaming)

You can manage the radio and stream music to it from your computer.

The following explanation assumes your computer's operating system is Windows 8. If you use a different operating system and require assistance, or if you have any other questions, please contact our customer **support** team.

Requirements:

- The radio and the computer must be on the same network.
- The radio must be authorised as a playback device on the computer.

Proceed as follows:

→ **Control Panel** → **Network and Internet** → **View network computers and devices**

The radio should be shown here.

- Right-click on the icon or designation of the radio and choose **Allow streaming to this device**
- Right-click again on the icon or designation of the radio and choose **Show device website** to change the friendly name of the device.
- A new browser window opens. You can make the desired changes here.

Use:

- The radio can now access shared directories on the computer, and you can stream audio files to the device for playback.
- The music directory of your music library is enabled as standard.
- Create and manage shared folders using Explorer or Windows Media Player.
- Right-click on the desired music file, choose **Play To**, and then select the designation of the radio.
- The radio begins playback of the music file.



9.3 Playback from the network – Accessing files using the radio

To access one of the existing network shared files directly from the radio, proceed as follows:
From the main menu or after pressing **[mode]** repeatedly, activate **Music player** mode.

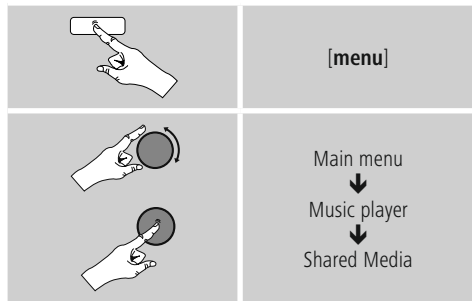

- Choose the correct device (home server, PC, etc.) and press **[enter/navigate]** to open the list of shared folders on that device.

You can now search for files, open a playlist, or search through the entire shared music folders. If you want to search through the entire selection of music, there are other sorting functions available (Album, Artist, Genre, Folder, etc.) that can help you find the desired file more quickly.

Note

These functions are only available if the ID3 tag and other file information have been maintained on the source device.

Prune servers:

To reset the list of servers connected to so far, press **[enter/navigate]**.

If you confirm by choosing **YES**, then all Common Media will be deleted.

9.4 Playback of playlist

You can create a local playlist on the radio, in which you save files shared on the network or from connected data storage devices.

- Under **Shared media/ USB playback**, choose the file to be added to the playlist.
- Press and hold **[enter/navigate]** for approx. 3 seconds until the display shows the message **Added to playlist**.

Note

You can also use playlists that were created on your Windows PC. (WPL = Windows Playlist) For example, Windows Media Player is suited for this purpose.

- To go directly to the playlist, do as follows:

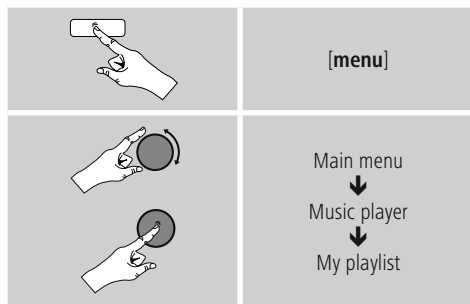

- To remove individual files from the playlist, choose the file and then press and hold **[enter/navigate]** for approx. 3 seconds.
- Confirm **Delete from My playlist** by choosing **YES** to delete the file from the playlist.

- To delete the entire playlist, proceed as follows:

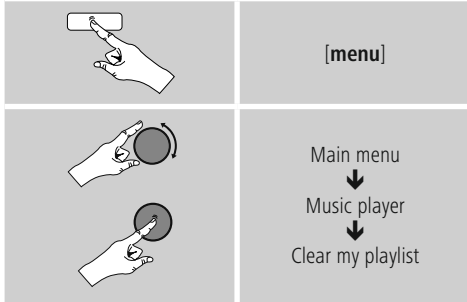

9.5 General playback options

These playback options, which are valid for all playback under **Music player**, can be found here:

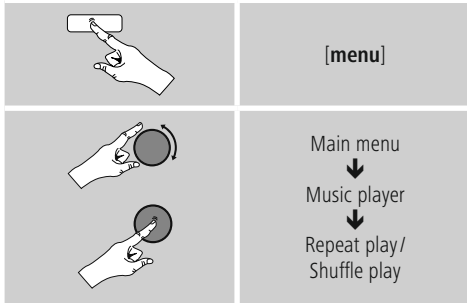

Repeat play: On / Repeat play: Off :

To turn the function **On** and **Off**, press [enter/navigate] repeatedly.

If this function is activated (**Repeat play: On**) the current track is repeated.

Shuffle play: On / Shuffle play: Off

To turn the function **On** and **Off**, press [enter/navigate] repeatedly.

If this function is activated (**Shuffle play: On**) the radio plays all tracks in random order.

10. DAB

The radio receives all established digital radio frequencies in the range of 174 MHz to 240 MHz (band III, channel 5A to 13F).

- From the main menu or after pressing [mode] repeatedly, activate operating mode **DAB (DAB Radio)**:

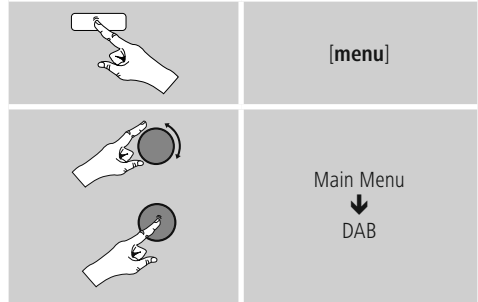

Alternatively, press [DAB] on the remote control to switch directly to this operating mode.

10.1 Search/ Automatic search

The automatic DAB channel search scans the DAB band III for available stations. After the station search, all interference-free stations are saved in alphabetical order. In Stations list a ? is displayed in front of the station names of stations found during a previous scan but which cannot currently be received.

The automatic DAB station search starts automatically when DAB mode is started for the first time; it is indicated by **Scanning...** and a status bar on the display.

If you would like to start the search again, proceed as follows:

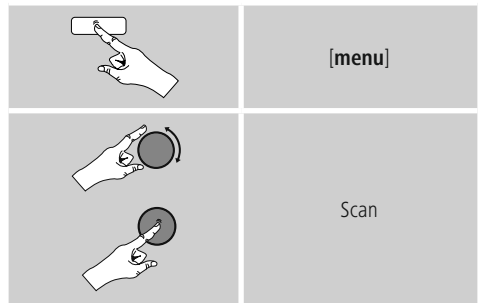

10.2 Manual station search

With the manual station search function you can search through individual frequencies and channels. If you know the frequency of the desired station and the automatic station search failed to find it, use this feature to set the reception frequency directly.

Proceed as follows, choosing a frequency range between 5A and 13F:

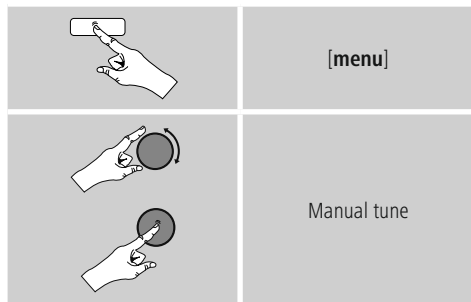

The **Stability** bar indicates the current signal strength. The marking along the bar indicates the value required for interference-free reception. If this value is not reached (the bar is empty), then the signal strength is not sufficient on this channel.

Note

- DAB/ DAB+ permits the transmission of several stations within a single frequency block. When sorting by ensemble the stations are displayed according to how they are distributed across the frequency blocks.

10.3 Station list

You can access the station list in DAB mode at any time via two methods:

- a) If a station is already playing, simply turn **[enter/navigate]**. The radio will then display the station list.

b)

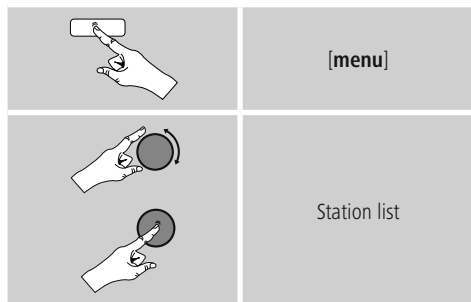

10.4 Sort station list

By default the radio sorts stations into alphabetical order. You can also sort by signal strength or ensemble. To change the sorting order, proceed as follows:

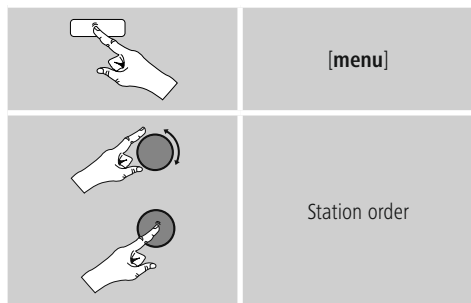

10.5 Edit station list

To remove stations that are not currently in the reception area, from your station list, proceed as follows:

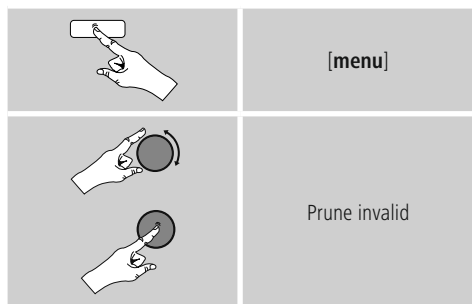

If you answer **YES**, then all currently unavailable stations will be removed from the station list.

10.6 Favourites

You can save up to 30 of your favourite stations for quick and direct access.

10.6.1 Save favourites

- Set the station that you would like to save as a favourite station preset.
- If the station is received, press and hold **[memory]** on front of the radio.



An overview window with the station presets should open after approx. 2 seconds.

- You can switch between the station presets (1 to 30) by turning **[enter/navigate]**.
- Press **[enter/navigate]** to save the station on the desired station preset.

10.6.2 Access favourites

Press **[memory]** to open the overview window with the list of saved stations.



Use **[enter/navigate]** to select one of your favourites.

i Note

Favourites cannot be deleted.

If all 30 station memory slots are filled and you wish to save a new station, choose one of the occupied slots. The station in this slot will be overwritten with the new station.

10.6.3 Management of favourites with the remote control

Favourites 1-10

The remote control enclosed has number keys 1-0 (0 \triangle 10). A favourite can be assigned to each of these number key.

- To save a favourite, press and hold the corresponding number key on the remote control (approx. 3 seconds).
- The radio confirms that the favourite has been saved by displaying **Preset stored**.
- To call up a favourite, briefly press the corresponding number key on the remote control.

Favourites 1-30 (alternative to number keys)

- Press and hold **[FAVORITES]** approx. 3 seconds to save a station on one of the 1-30 favourite station presets. An overview window with the station presets should open after approx. 2 seconds.
- You can switch between the station presets (1 to 30) by pressing the favourite keys **[+]/[-]** (by turning **[enter/navigate]**).
- Press **[OK]** (**[enter/navigate]**) to save the station on the desired station preset.
- To call up a favourite, briefly press **[FAVORITES]**, select the desired station preset by pressing the favourite keys **[+]/[-]** (by turning **[enter/navigate]**) and confirm the selection by pressing **[OK]** (**[enter/navigate]**).



10.7 DRC (Dynamic Range Control)

Some radio stations in the DAB network support an audio level control that is activated at varying volumes during playback. If the audio level suddenly rises during playback, DRC automatically reduces the volume. The same happens if playback suddenly becomes quieter, with the radio then increasing the volume.

This radio has three different settings for DRC:

DRC high: total equalisation of different volumes. Strong compression can audibly reduce the dynamics of a music title.

DRC low: partial equalisation of different volumes. More subtle compression, without too much loss of dynamics.

DRC off: no equalisation.

Proceed as follows to do the settings:

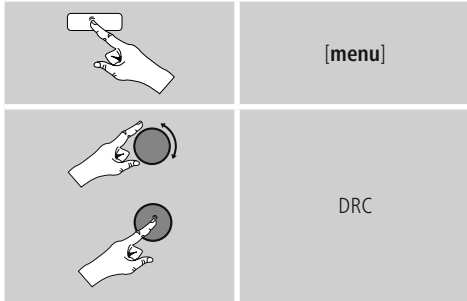

11. FM

From the main menu or after pressing [mode] repeatedly, activate operating mode **FM (FM Radio)**:

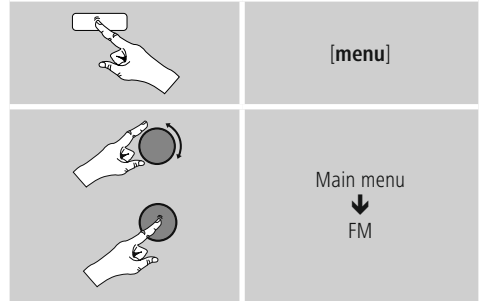

Alternatively, press [FM] on the remote control to switch directly to this operating mode.

Stations that broadcast additional information regarding the station and the programme, are highlighted on the display with an RDS icon (Radio Data System).

Additional information were displayed by pressing [info].

11.1 Scan setting

The search run setting allows you to determine whether stations with low signal strength are ignored during the automatic search run.

Proceed as follows:

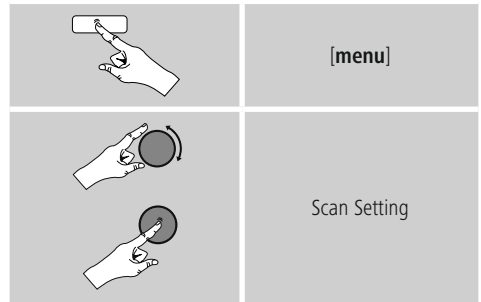

- To have the search run stop only at stations with high signal strength, confirm the subsequent query by selecting **YES**. Otherwise, the search run will stop at every station for which a signal is received.

11.2 Automatic station search

- Press and hold **[enter/navigate]** until the automatic station search starts.
- The radio stops the search and starts playback when it finds a station.
- Press **[enter/navigate]** to continue the search until the next station is found.

11.3 Manual station search

When you make station settings manually, you can define the desired frequency yourself and tune into stations that were ignored during automatic station search because their signals were too weak.

- Turn **[enter/navigate]** (left: -0.05 MHz / right: $+0.05$ MHz) until you see the desired frequency. Wait a moment until playback of the received station signal begins.

11.4 Favourites

You can save up to 30 of your favourite stations for quick and direct access.

11.4.1 Save favourites

- Set the station that you would like to save as a favourite station preset.
- If the station is received, press and hold **[memory]** on front of the radio.



An overview window with the station presets should open after approx. 2 seconds.

- You can switch between the station presets (1 to 30) by turning **[enter/navigate]**.
- Press **[enter/navigate]** to save the station on the desired station preset.

11.4.2 Access favourites

Press **[memory]** to open the overview window with the list of saved stations.



Use **[enter/navigate]** to select one of your favourites.

Note

Favourites cannot be deleted.

If all 30 station memory slots are filled and you wish to save a new station, choose one of the occupied slots. The station in this slot will be overwritten with the new station.

11.4.3 Management of favourites with the remote control

Favourites 1-10

The remote control enclosed has number keys 1-0 (0 \triangleq 10). A favourite can be assigned to each of these number key.

- To save a favourite, press and hold the corresponding number key on the remote control (approx. 3 seconds).
- The radio confirms that the favourite has been saved by displaying **Preset stored**.
- To call up a favourite, briefly press the corresponding number key on the remote control.

Favourites 1-30 (alternative to number keys)

- Press and hold **[FAVORITES]** approx. 3 seconds to save a station on one of the 1-30 favourite station presets. An overview window with the station presets should open after approx. 2 seconds.
- You can switch between the station presets (1 to 30) by pressing the favourite keys **[+]/[-]** (by turning **[enter/navigate]**).
- Press **[OK]** (**[enter/navigate]**) to save the station on the desired station preset.
- To call up a favourite, briefly press **[FAVORITES]**, select the desired station preset by pressing the favourite keys **[+]/[-]** (by turning **[enter/navigate]**) and confirm the selection by pressing **[OK]** (**[enter/navigate]**).



11.5 Audio setting

For some stations with a weak signal, quality can be slightly improved by playing them in mono quality. You can enable this function in the menu, and the radio will automatically switch to mono reception when signal quality is poor.

To change the audio setting, proceed as follows:

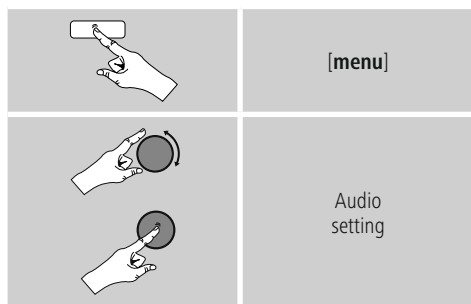

12. Auxiliary Input

Via the analogue audio input (**AUX IN** socket) you can connect mobile devices (for example smartphone, tablet PC, M3 player etc.) to the radio and play the audio files using the radio's speakers.

- From the main menu or after pressing [mode] repeatedly, activate **Auxiliary Input (Aux in)** mode.

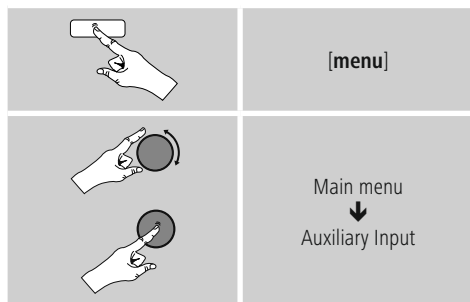

Alternatively, press [AUX] on the remote control to switch directly to this operating mode.

- Connect your mobile terminal device to the audio in (the **AUX IN** socket) of the radio using a 3.5-mm TRS stereo cable.
- Start and control audio playback using the controls of the connected terminal device.

13. Sleep

The radio has a sleep function, after a defined time the radio switches to standby mode.

- Repeatedly press [ Z^zz] or [SLEEP] on the remote control to set the desired time interval (Sleep OFF/ 15/30/45/60/90/120 minutes).



Alternatively, set the time interval from the main menu using [enter/navigate]:

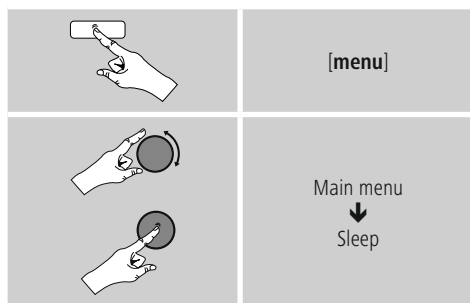

- After the defined time the radio switches to standby mode.
- Press [**z**] - or [**volume +/-**] [**⏻**], to turn the radio back on.
- If a time interval is already activated, you can change or disable it at any time by again pressing [**z**] or [**SLEEP**] on the remote control.

Note - Backlight

There is a separate setting for the backlight when the timer (snooze) is activated. For example, it can be set to be dimmer than in normal operation.

15.9. Backlight

14. Alarms

The Radio has two individually adjustable alarm times.

14.1 Alarm settings

- You can access the alarm settings as follows:



- Or:

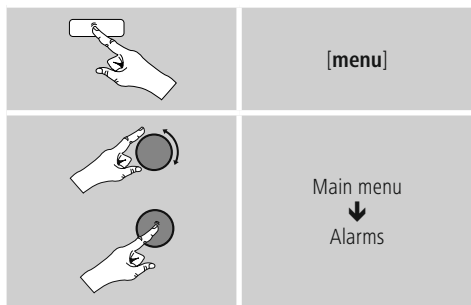

- Alarm 1 and alarm 2 are configured identically. So you can save two different alarm times. Select alarm 1 or 2 and then make the following settings by means of [**enter/navigate**]:

Enable:

Choose when the alarm is to activate:
→ Off – Daily – Once – Weekdays – Weekends

Date and time:

If you selected **Once**, enter the date and time for the one-off alarm.

Time:

First choose the hour, then the minute at which the alarm is to activate.

Mode:

Set whether you wish to be woken by an alarm tone (**Buzz**), by **DAB, FM** or by the **Internet radio**.

Preset:

If you selected **Internet radio/ DAB/ FM**, choose which station or podcast you wish to be woken with. You can choose any of the 30 favourite station slots or the **Last listened**.

Volume:

You can set the volume at which the alarm sound should be played. This setting makes it irrelevant how loud you last listened to the radio.

Save:

Confirm this menu item to complete your alarm settings.

Note

- When using **Internet radio** for the alarm sound take care that the internet connection will be available at the time of the alarm. If no internet connection is available the radio instead uses the wake-up buzzer (**Buzz**).
- It is recommended to allow the radio to update the time automatically. This ensures that the time is always correct even if there is a separation of power supply – for example a power cut.

14.2 Activating/ deactivating the alarm

- Confirm the menu item **Save** in alarm settings to activate the alarm.
- Disable the alarm by setting the **Mode**: to **Off**



14.3 Stopping the alarm/ Snooze function

Alarm tone (Buzz)

- When the alarm activates, press [**Z^zz**] or [**volume -/+**] / [], to stop the alarm.
- Repeatedly press [**Z^zz**] or [**SNOOZE**] on the remote control to activate snooze mode.
- The alarm turns off for the selected time interval (5/10/15/30/60 minutes) before activating once again.

Internet radio/ DAB/ FM

- When the alarm activates, press [**volume -/+**] / [] to stop the alarm.
- Repeatedly press [**Z^zz**] or [**SNOOZE**] on the remote control to activate snooze mode.
- The alarm turns off for the selected time interval (5/10/15/30/60 minutes) before activating once again.
- Repeatedly press [**Z^zz**] or [**SNOOZE**] on the remote control to activate **ON** instead of snooze mode. The radio now stays switched on.
- If the alarm is not stopped, the radio automatically switches into standby mode after one hour.

15. System settings

You can modify all settings and access important information about the radio in the System settings.

15.1 Equaliser

The equaliser allows you to adjust the sound of the radio to suit your preferences by amplifying or reducing the amount of bass or treble in the audio .

You can choose from preconfigured profiles, adjusted to suit a variety of music genres, or create your own custom profile.

- To set the Equaliser, proceed as follows:

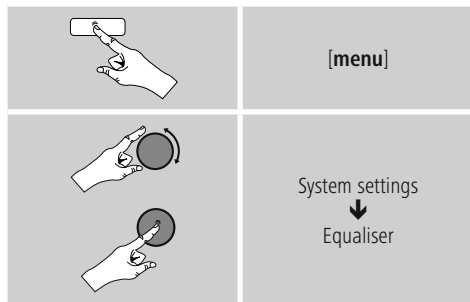

- Use [**enter/navigate**] to choose one of the preconfigured profiles.
- To create your own equaliser profile, choose the option **My EQ profile setup**.
- This takes you to the settings for **Bass**, **Treble** and **Loudness** (volume amplification).
- To adjust a particular value, press [**enter/navigate**] at the corresponding menu item and then change the value by turning [**enter/navigate**]. If playback is already started when you modify these settings, you can hear the changes in the audio immediately.
- Confirm your settings by pressing [**enter/navigate**] once more.
- Complete the configuration process by pressing [**back**] on the device and confirm the saving of settings by pressing [**enter/navigate**].
- To use the new profile, choose the item **My EQ**.

15.2 Network

15.2.1 Network wizard – Configuration of internet connection / Automatic search

The **Network wizard** supports you to set up a connection between the radio and internet. Hereby you can choose between a wired LAN connection and a wireless connection using WLAN/Wi-Fi. More methods of configuration and detailed information are amplified subsequently.

- You can start the **Network wizard** as follows:

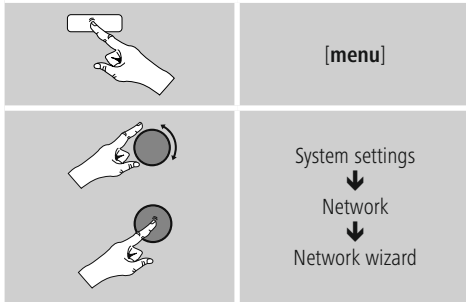

- When the wizard is started, the radio searches for WLAN (WiFi) connections and then shows a list of the available networks.
- Turn **[enter/navigate]** to switch amongst the networks discovered. At the bottom of the list are options to restart the search (**[Rescan]**), select a cable connection (**[Wired]**) or configure the connection yourself (**[Manual config]**).
- If your network is not found or the SSID (Service Set Identification, that is, the name of your network) is not shown, the network may be hidden or out of range. In this case, try manual configuration or connecting by LAN cable.

15.2.2 Wireless network connection (WLAN)

Depending on the network, there are a number of ways to connect to it.

Networks that support connection via WPS (Wi-Fi Protected Setup) are identified in the list as **[WPS]**.

Other connections are either open networks or connections protected with a PSK, or Pre-Shared-Key.

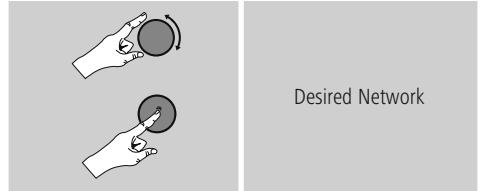

WPS-/PSK-/ open network connection

WPS allows simple and nevertheless protected connection of the radio to the network. Two options are available for this purpose: The connection can be set up by means of PBC, or Push-Button Configuration, or by the PIN procedure, in which the web interface of your router prompts you to enter a randomly generated sequence of numbers.

PBC setup

- Select your desired network. (Indicated by the prefix **[WPS]**)
- In the WPS menu, choose the **Push Button** option and confirm your selection by pressing **[enter/navigate]**.
- Press the WPS button on your router or current access point. This can often be done using the web interface, as well.
- Consult the operating instructions of your router or access point for details.
- Once the process has been started on the router or access point, the radio should be able to find and connect to the network.



- Alternatively, PBC setup can be initiated from the internet settings of the radio:

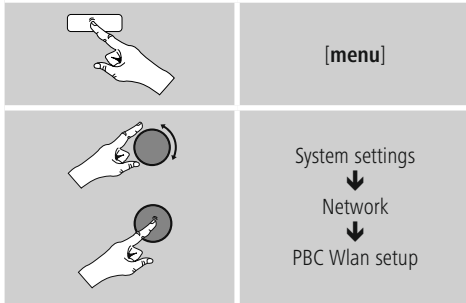

PIN setup

- Select your desired network. (Indicated by the prefix **[WPS]**)
- In the WPS menu, choose the **Pin** option and confirm your selection by pressing **[enter/navigate]**.
- The radio generates an 8-digit code, which must be entered into the web or user interface of your router or access point.
- Consult the corresponding handbook for details on configuring the router or access point.

Skip WPS / Pre-Shared Key (PSK) setup

- Choose the item **Skip WPS** to proceed to key entry.
- In networks that do not support WPS, you will go directly to key entry.
- In the input screen, enter the whole key and then confirm with **OK**.
- If the key was entered correctly, the radio connects to the access point and establishes the internet/network connection..

Note

- Often the Pre-Shared Key is printed on the back or bottom of the router or access point.
- When entering the key, take notice of capitalisation.

Open network

Note

- We recommend against establishing unsecured connections and advise you to always protect your network against unauthorised access.
- If you plan to use an open network, you just have to select the network ID from the list of available networks and confirm.
- The radio then connects immediately to the network.

15.2.3 Wired network connection (LAN)

- Connect the radio to the router using a LAN cable. This method of direct connection is the most reliable and least susceptible to interference.
- The cable connection is listed amongst the available connections as **Wired**. Simply select it to proceed. If the DHCP server of the router or access point is active, then the connection is now established automatically.
- To find out how to determine whether the DHCP server is active, please consult the operating instructions of your router or access point.

15.2.4 Manual configuration of network connection – wireless (WLAN) and wired (LAN)

- To manually configure the network connection, proceed as follows:

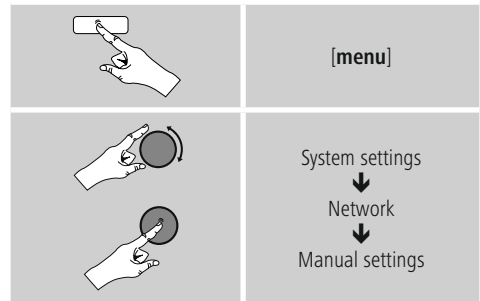

Manual configuration wired (LAN) – DHCP enable

- Select the option **Wired**.
- Select the option **DHCP enable**.
- The connection is now established. No further setting adjustments are required.

Manual configuration wired (LAN) – DHCP disable

- Select the option **Wired**.
- Select the option **DHCP disable**.
- Enter the necessary network information, such as the IP address, subnet mask, gateway address and DNS (primary and secondary).
Find this information in the web interface of your router or access point, or ask your network administrator. Once all the information has been entered correctly, confirm to proceed. The radio now attempts to establish the connection.

Manual configuration wireless (WLAN) – DHCP enable

- Select the option **Wireless**.
- Select the option **DHCP enable**.
- In the input screen, enter the whole SSID (network name) and then confirm with **OK**.
- Now choose the security standard used by the network. This can be found in the configuration options of your router or access point.
- Depending on the encryption used, you may need to enter the network key before the connection is established..

Manual configuration wireless (WLAN) – DHCP disable

The method described here assumes the DHCP server is active (**manual wireless configuration(WLAN) – DHCP enable**). However, the network information such as IP address, subnet mask, gateway address, and DNS (primary and secondary) must still be entered. Find this information in the web interface of your router or access point, or ask your network administrator. Once all the information has been entered correctly, confirm to proceed. The radio now attempts to establish the connection.

15.2.5 View settings

Here you can find all the most important information about all network connections currently used or configured on the radio, such as: MAC address, WLAN region, DHCP active/disabled, SSID, IP address, subnet mask, gateway address, DNS (primary and secondary), etc.

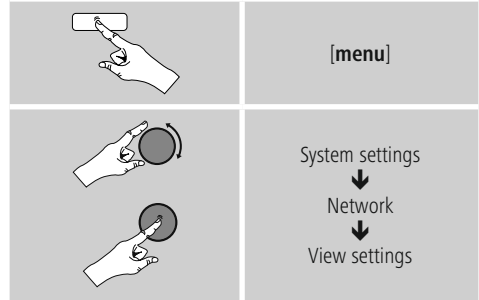

15.2.6 NetRemote PIN Setup / Smart Radio-App

The radio can be controlled using the application Hama Smart Radio.

For this, you have to have installed the app on your terminal device (for example smartphone or tablet PC) and your device has to be in the same network as your radio. The PIN saved in the radio is to increase security and prevents other users from connecting with the radio. If the app is started on your terminal device (for example smartphone or tablet PC) and it tries to connect with the radio, a window will appear on your device requiring you to enter the PIN.

- You can find and change the PIN as follows:

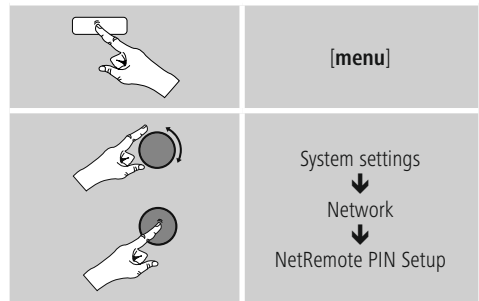

- The radio PIN is set to **1234** by default.
- Use **[enter/navigate]** to make changes.
- Confirm your changes by choosing **OK**.



15.2.7 Network profile

The radio automatically saves all successfully connected network profiles. This means that re-establishing these connections (for example, after the radio was disconnected from the power supply) does not require you to re-enter the network access information.

- To remove network profiles individually, proceed as follows:

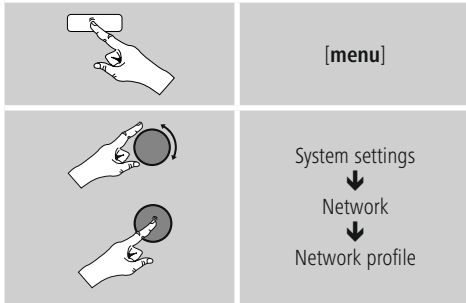

- Select a network profile and press **[enter/navigate]** to delete it.
- Confirm the prompt querying if you want to delete the profile with **YES**.
- A profile that is currently active, or that is in use, cannot be deleted.

Note - Data security

- Before giving or selling the radio to someone else, we recommend performing a Factory Reset.
- This will completely and permanently delete all network information and connections stored on the device.

15.2.8 Keep network connected

This setting is a radio energy-saving function.

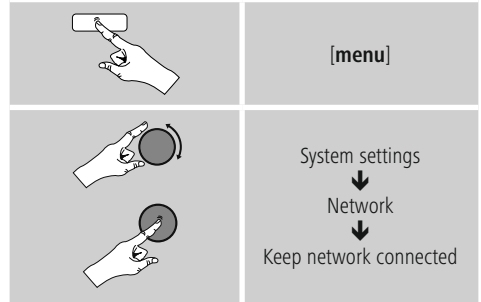

If this feature is disabled (**NO #**), the network module will be switched off whenever the radio is not actively using the network connection (such as in standby mode or DAB reception). This means the radio will not be accessible via the network from your PC, smartphone or tablet. You should enable (**YES #**) this menu item if you want to use streaming or control functions via the app. This function is disabled by default.

15.3 Time/ Date

To access the time settings, proceed as follows:

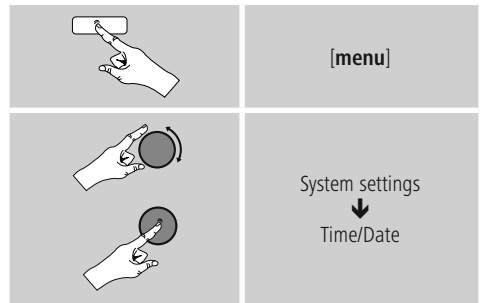

Auto update

• Update from Network

Choose this option to set the time and date automatically from the internet. Set the timezone of your current location (**Set timezone**) and, if desired, turn on automatic adjustment between summer time and winter time (**Daylight savings** → **ON**).



• Update from DAB/ FM

If automatic time and date adjustment is activated, the device receives time and date information from the station over the FM/DAB/DAB+ radio network. This is the best way to ensure that the clock will run accurately and the alarm will trigger at the correct time, even after power outages.

No update

The time and date (**DD-MM-YYYY**) must be set manually; no automatic calibration takes place.

Set Time/ Date

Set the date (**DD-MM-YYYY**) and time (**hh:mm**) manually using **[enter/navigate]**.

Set format

Choose between 12 and 24 hours format.

15.4 Language

To change the menu language from that selected at first-time startup, proceed as follows:

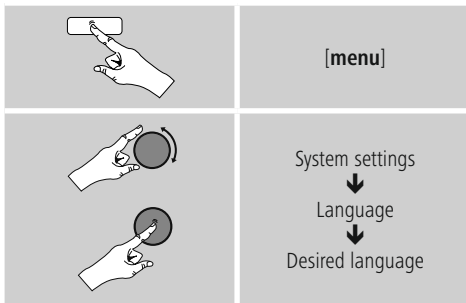

15.5 Factory Reset

To reset the radio to the factory default settings, proceed as follows:

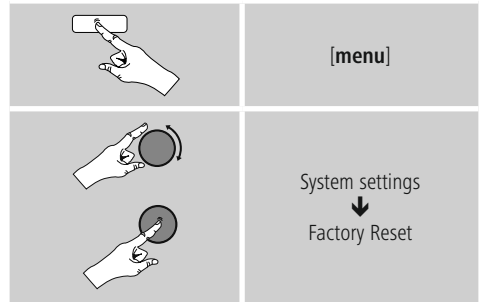

Confirm the following prompt with **YES** to reset the radio to the factory default settings.
All settings made previously are deleted.

Note

- Resetting to the factory default settings can solve some problems and malfunctions.
- However, all settings made previously, such as custom equaliser presets, favorites, and network profiles, are permanently deleted.

15.6 Software update

We are constantly developing new software features and improvements for our radios to fix problems, add functionality, etc.

We recommend that you keep your radio's software up to date.

- Proceed as follows:

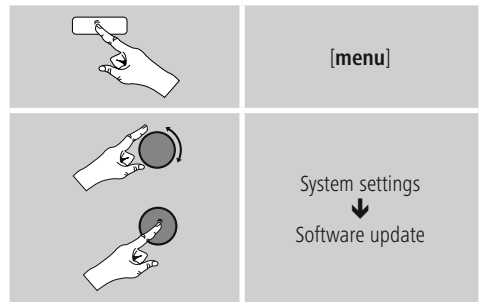

- Set **Auto-check setting** to **YES** to have the radio automatically check for new software updates at regular intervals. (Recommendation)
- Choose **Check now** to manually start a check for software updates.

Warning

- Make sure that the radio has a stable power supply before you start a software update.
- Power supply failure during a software update can cause irreparable damage to the radio.

15.7 Setup wizard

You can restart the setup wizard (5.4.1. Setup wizard) at any time by proceeding as follows:

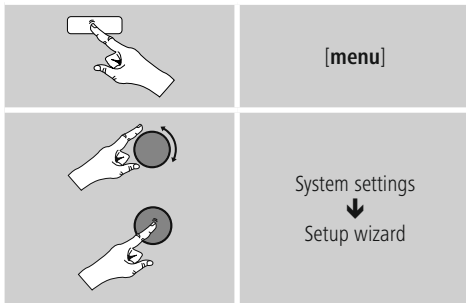

15.8 Info

- To have the radio display current information about its hardware and software (version numbers, device designation, radio ID, etc.), proceed as follows:

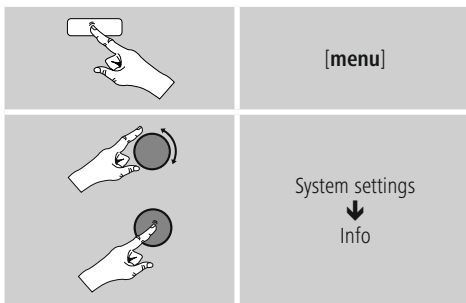

- If you have already registered your radio on the online portal of Frontier Silicon (<http://www.wifiradio-frontier.com>), then you can find out the radio ID there, as well.

15.9 Backlight

The backlight can be configured for each operating mode (Operation Mode, Standby Mode, Slumber Mode) separately.

- Proceed as follows:

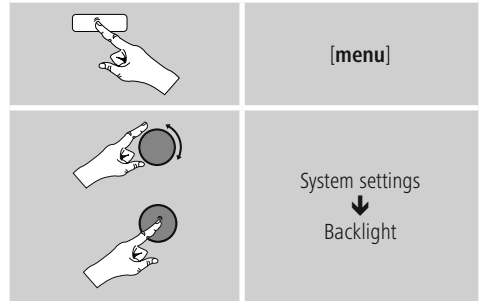

- For the operation modes **Operation Mode** and **Slumber mode**, select between various brightness levels.
- For **Standby Mode**, you may also choose a brightness level for the backlight when the radio is in standby (**Standby Level**). Alternatively, you can set the backlight to turn off completely in standby (**Standby Level** → **Off**).
- Choose a time interval for **Timeout**. When the radio is in standby, press **[enter/navigate]** to illuminate the display at the brightness level set for that operating mode for the selected interval of time.
- Alternatively, you can disable this feature (**Timeout** → **Off**).

Alternatively, press **[Backlight]** on the remote control to directly adjust the backlight setting for the current operating mode.



15.10 AUX: Auto-Standby

In **Aux in (Auxiliary Input)** operating mode, the radio switches to standby mode after 15 minutes, by default. To disable (**NO**) or activate (**YES**) this feature, proceed as follows:

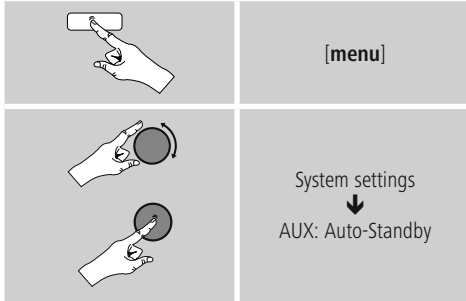

16. Hama Smart Radio (Android / iOS)

The Hama Smart Radio app allows you to access and control many features of the radio from your tablet computer or smartphone, without using the remote control.

The current version of the app can be found here:

For iPhone and iPad



<http://www.hama.com/hama-smart-radio-apple-itunes>

For Android smartphones and tablets



<http://www.hama.com/hama-smart-radio-google-play>

Once installation is complete, tap this icon on your smartphone or tablet to launch the app.



16.1 Preparation

Make sure that your radio and your smartphone are both connected to the same network. Company networks and networks with strict security measures in place can often cause problems with the connection between the radio and the app.

The radio should be configured to uphold the network connection even when internet radio stations are played and to not switch into standby mode. Otherwise the connection cannot be established.

16.2 First startup

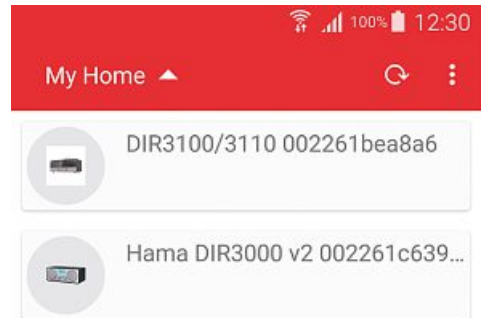

When the app is started up for the first time, it loSELECTS for compatible radios on the network. The radio is represented by a small preview picture and its designation (friendly name and MAC address). Choose the radio you wish to connect to, and the app establishes the connection.



16.3 Interface of the app



1	Source selection / active device
2	Settings
3	Playback source (DAB, FM, Internet, etc.)
4	Playback window
5	Search (stations or directories)
6	Manage favourites
7	Shuffle / Mix
8	Share
9	Repeat (function mode-dependent)
10	Station information
11	Navigation buttons (function mode-dependent)
12	Navigation buttons (function mode-dependent)
13	Navigation buttons (function mode-dependent)
14	Mute
15	Volume control

16.4 Source selection

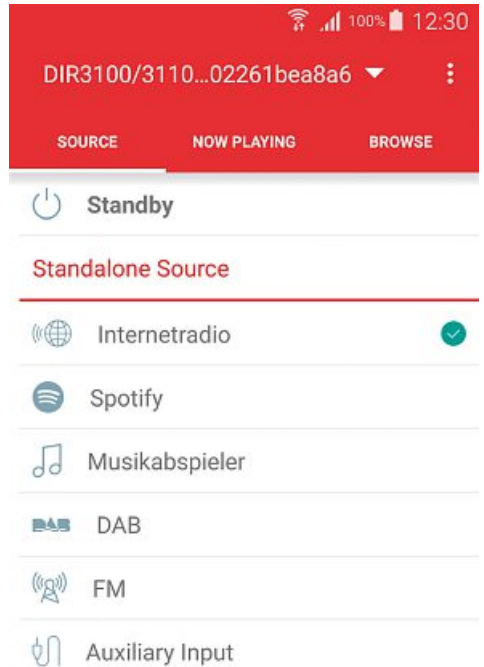

The source setting allows you to change the radio's current operating mode.

You can also operate the music player and access files shared on the network or saved on USB storage devices that are connected to the radio.

To use Spotify, the radio must have been connected to the original Spotify app at least once so that the user data are saved on the radio. After that you can control playback of Spotify playlists using the Smart Radio app.

16.5 Station search and favourites

16.5.1 Managing favourites

To access favourites management, tap this button in the playback window (6).

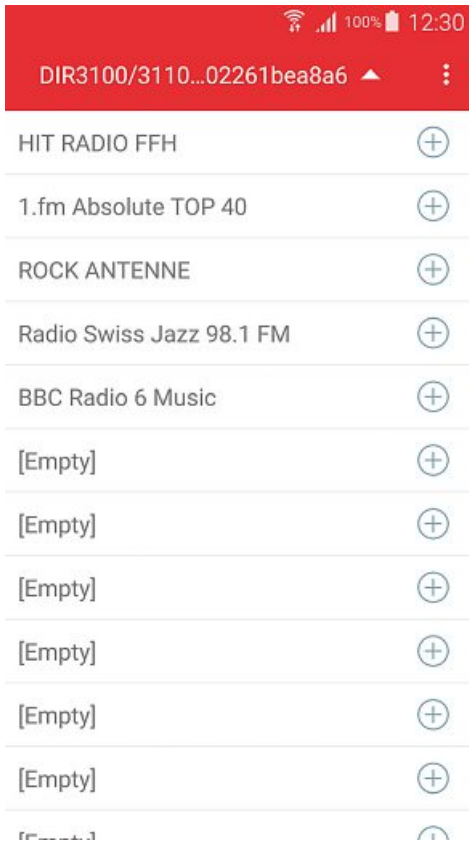

The overview that opens shows any saved favourites, which you can open by tapping on them. To add a station, tap the ⊕ which can be found at the end of a line.

Lines marked **[empty]** can be freely assigned to a new favourite. Occupied slots can be overwritten with new favourites.

16.5.2 Searching for stations / station lists

You can also search for stations using the app. Tap any of the search results to open it.

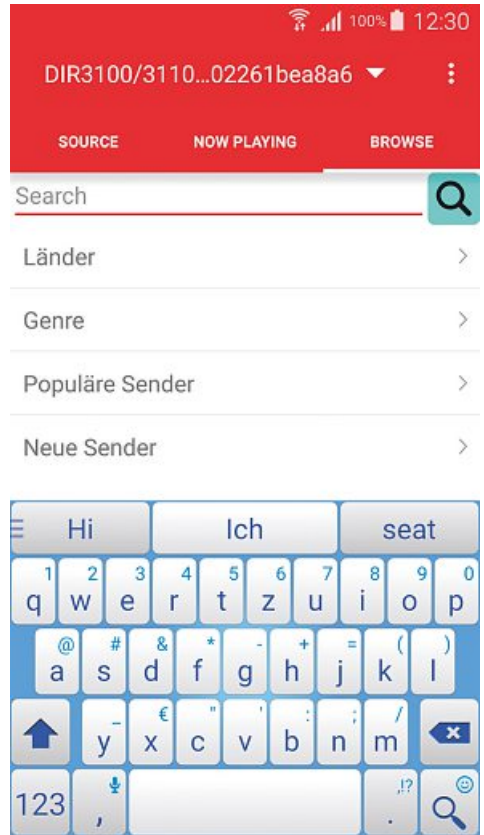

To search, first tap the menu item “Browse” (3). Then you can either choose from the sorted list, as in the regular interface of the radio, or use the search field. When you tap the search field, the on-screen keyboard opens. Enter your search terms and confirm.

The app now searches the vTuner database for the search terms and lists resulting matches.

16.6 Settings and standby



To access the radio's settings, or to switch it into standby mode using the app, tap the settings icon (2) and then on "Settings". Tap "Standby" to put the radio in standby mode.



The settings allows you to configure the equaliser, check for and install software updates, change the network access PIN, and see information about the radio

The software update and equaliser features can be configured as when using the radio interface. The information window allows you to change the device name and provides information about the current firmware version, IP address, and MAC address of the radio. To change the device designation, tap the pen icon next to the current designation. The on-screen keyboard appears with a new window in which the current designation is displayed and can be modified.

16.7 Additional functions (music player / Spotify)

	Shuffle On / Off	Activate this feature to have titles in playlists and folders played back in random order. (Random playback)
	Repeat	Activate this feature to repeat titles.
	Share title	Tap this icon to share the current station and information about the current title. This information can be shared on Whatsapp, Facebook, etc.

17. Care and Maintenance

- Only clean this product with a slightly damp, lint-free cloth and do not use aggressive cleaning agents.
- If you do not use the product for a long time, turn off the device and disconnect it from the power supply. Store it in a clean, dry place out of direct sunlight.

18. Warranty Disclaimer

Hama GmbH & Co KG assumes no liability and provides no warranty for damage resulting from improper installation/ mounting, improper use of the product or from failure to observe the operating instructions and/ or safety notes.



19. Service and Support

Please contact Hama Product Consulting if you have any questions about this product
Hotline: +49 9091 502-115 (German/English)

Further support information can be found here:
www.hama.com

20. Recycling Information

Note on environmental protection:



After the implementation of the European Directive 2012/96/EU and 2006/66/EU in the national legal system, the following applies: Electric and electronic devices as well as batteries must not be disposed of with household waste. Consumers are obliged by law to return electrical and electronic devices as well as batteries at the end of their service lives to the public collecting points set up for this purpose or point of sale. Details to this are defined by the national law of the respective country. This symbol on the product, the instruction manual or the package indicates that a product is subject to these regulations. By recycling, reusing the materials or other forms of utilizing old devices/ batteries, you are making an important contribution to protecting our environment.

21. Declaration of Conformity

CE Hama GmbH & Co KG hereby declares that the device complies with the essential requirements and other relevant provisions of Directive 2014/53/EU. See www.hama.com for the declaration of conformity with the relevant directive.



hama®

Hama GmbH & Co KG
86652 Monheim/Germany
www.hama.com

The Spotify software is subject to third party licenses found here:
www.spotify.com/connect/third-party-licenses

All listed brands are trademarks of the corresponding companies. Errors and omissions excepted, and subject to technical changes. Our general terms of delivery and payment are applied.